

Godox 神牛

TTL Li-ion Camera Flash

VING 逸客

V860 ^C
For Canon

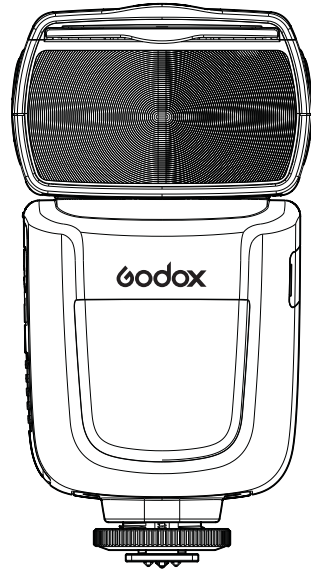

INSTRUCTION MANUAL
说明手册

中英文双语 / Chinese English Bilingual

Before using this product

Please read this user manual carefully in order to ensure your safety and the proper operation of this product. Keep for future reference.

Foreword

Thank you for purchasing this product.





VING series is a Godox original product and the world's first Li-ion powered camera flash, pioneering innovation in the industry. The LiPo battery obviously enhances recycle, runtime, mobility, and portability performance. This model applies to Canon EOS series cameras and is compatible with E-TTL II autoflash. With this E-TTL II compatible flash, your shooting will become simpler. You can easily achieve a correct flash exposure even in complex light-changing environments. This camera flash features:

- GN58 (m ISO 100, @105mm). Adjust from 1/1 to 1/128 in 1/3rd stops
- Support Canon E-TTL II autoflash, Manual and Multi flash modes
- Workable as Master and Slave unit in a wireless flash group
- Pro 2000 mAh Li-ion Battery—max. 1.5s recycle—650 full power pops
- Super value and no messing with AA's, external power pack, or chargers
- Use optional FT-16S to adjust flash parameters & trigger the flash
- Stable consistency and color temperature with good even lighting
- User-friendly LCD display & control panel with firmware upgrade

For Your Safety



- ▲ Always keep this product dry. Do not use in rain or in damp conditions.
- ▲ This product contains high-voltage electronic parts. Touching the high-voltage circuit inside it may result in electric shock. Do not disassemble. Should repairs become necessary, this product must be sent to an authorized maintenance center.
- ▲ Stop using this product if it breaks open due to extrusion, falling or strong hit. Otherwise, electric shock may occur if you touch the electronic parts inside it.
- ▲ Do not fire the flash directly into the eyes (especially those of babies) within short distances. Otherwise visual impairment may occur. When taking pictures for babies, keep the flash unit at least 1 meter (3.3 feet) away from them. Using bounce flash to reduce light intensity is also recommended.
- ▲ Do not use the flash unit in the presence of flammable gases, chemicals and other similar materials. In certain circumstances, these materials may be sensitive to the strong light emitting from this flash unit and fire or electromagnetic interference may result.
- ▲ Do not leave or store the flash unit in places where the ambient temperature reads over 50°C (e.g. in automobile). Otherwise the electronic parts may be damaged.

Contents

01	Foreword
02	For Your Safety
05	Name of Parts
	Body
	Control Panel
	LCD Panel
	What's in the Box of V860C Kit?
	What's in the Box of V860C (only flash unit)?
	Separately Sold Accessories
08	Battery
	Features
	Cautions
	Loading and Unloading the Battery
	Battery Level Indication
09	Attaching to a Camera
09	Power Management
09	Flash Mode—E-TTL Autoflash
	 FEC (Flash Exposure Compensation)
	 FEB (Flash Exposure Bracketing)
	FEL: Flash Exposure Lock
	 High-Speed Sync
	 Second-Curtain Sync
12	Flash Mode—M: Manual Flash
13	Flash Mode—Multi/Stroboscopic Flash
14	Wireless Flash
	Wireless Settings
	Fully Automatic Wireless Flash
	Master Unit's Flash OFF
	Setting the Communication Channel
	Setting the Flash Output for Slave Units
19	Other Applications
	Wireless Control Function
	Sync Triggering
	Modeling Flash
	Auto Focus Assist Beam
	Bounce Flash
	Creating a Catchlight
	ZOOM: Setting the Flash Coverage and Using the Wide Panel
22	C.Fn: Setting Custom Functions
23	Control with the Camera's Menu Screen
24	Protection Function
25	Technical Data
26	Troubleshooting
27	Firmware Upgrade
27	Compatible Camera Models
27	Maintenance



Conventions used in this Manual

- This manual is based on the assumption that both the camera and camera flash's power switches are powered on.
- Reference page numbers are indicated by "p.**".
- The following alert symbols are used in this manual:
 -  The Caution symbol gives supplemental information.
 -  The Note symbol indicates a warning to prevent shooting problem.

Name of Parts

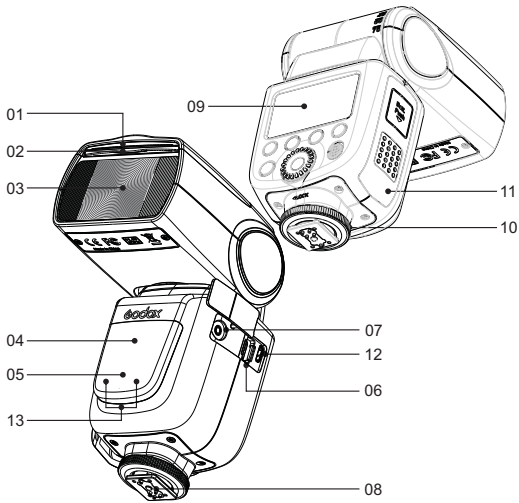

• Body

- | | |
|---------------------------|---------------------------------|
| 01. Catchlight Panel | 08. Hotshoe |
| 02. Built-in Wide Panel | 09. LCD Panel |
| 03. Flash Head | 10. Lock Ring |
| 04. Optic Control Sensor | 11. Li-ion Battery Compartment |
| 05. Focus Assist Beam | 12. USB Port |
| 06. Wireless Control Port | 13. Slave Flash Ready Indicator |
| 07. Sync Cord Jack | |

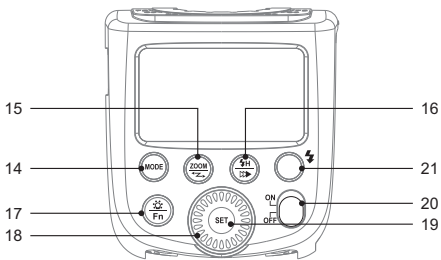

• Control Panel

- | | |
|---|---|
| 14. Mode Selection Button | 17. LCD Panel Illumination / Custom Function Button |
| 15. Zoom Button / Wireless Selection Button | 18. Select Dial |
| 16. HSS (FP flash) / Shutter Curtain Synchronization Button | 19. Set Button |
| | 20. Power Switch |
| | 21. Test Button / Flash Ready Indicator |

• LCD Panel

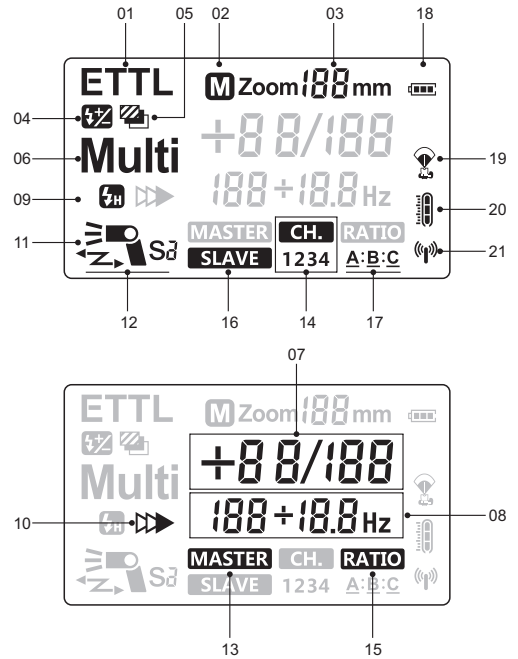

- | | |
|--|---|
| 01. < E TTL > E TTL Autoflash | 12. < S1/S2 > S1/S2 Optic Slave Flash |
| 02. < M > Manual Zoom | 13. < MASTER > Master |
| 03. Zoom Focal Length | 14. < CH. > Channel |
| 04. < 1/2 > Flash Exposure Compensation | 15. < RATIO > Flash Ratio |
| 05. < [bracket] > Flash Exposure Bracketing | 16. < SLAVE > Slave |
| 06. < M/Multi > Manual Flash / Multi Flash | 17. < A:B:C > Slave ID |
| 07. Manual Flash Output Level | 18. < [battery] > Battery Level Indication |
| 08. Multi Flash Times / Frequency | 19. < [output] > Max. Output Indication |
| 09. < [HSS] > High-Speed Sync (FP flash) | 20. < [temp] > Overtemperature Indication |
| 10. < [second-curtain] > Second-Curtain Sync | 21. < [signal] > Wireless Signal Transmission |
| 11. Wireless Flash Modes | |
| Master Flash ON: [ON icon] | |
| Master Flash OFF: [OFF icon] | |
| Exit Master-Slave: [EXIT icon] | |
| Slave Flash: [SLAVE icon] | |

• What's in the Box of V860C Kit?

1. Flash unit
2. Li-ion Battery Pack
3. Battery Charger
4. Battery Charger Cable
5. Mini Stand
6. Protection Case
7. Instruction manual

• What's in the Box of V860C (only flash unit)?

1. Flash unit
5. Mini Stand
6. Protection Case
7. Instruction manual

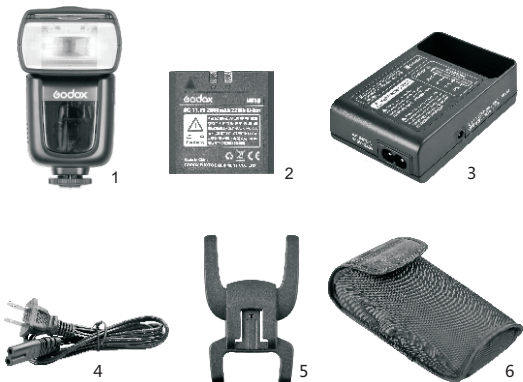

• Separately Sold Accessories

The product can be used in combination with the following accessories sold separately, so as to achieve best photography effects:

FT-16S power & trigger control, Car charger, Mini softbox, White & Silver reflector, Honeycomb, Color gels, Snoot, etc.



Battery

• Features

1. This flash unit uses Li-ion polymer battery which has long runtime. The available charge-and-discharge times are 500.
2. It is reliably safe. The inner circuit is against overcharge, overdischarge, overcurrent, and short circuit.
3. Take only 2.5 hours to fully charge the battery by using the standard battery charger.

• Cautions

1. Do not short circuit.
2. Do not expose to rain or immerse into water. This battery is not water proof.
3. Keep out of reach of children.
4. No over 24 hours' continuous charging.
5. Store in dry, cool, ventilated places.
6. Do not put aside or into fire.
7. Dead batteries should be disposed according to local regulations.
8. If the battery had ceased using for over 3 months, please make a full recharge.

• Loading and Unloading the Battery

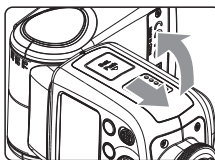

- 1 To load the battery, push the battery compartment cover downward and open it.

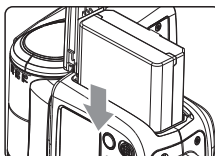

- 2 According to the triangle sign on the battery pack, insert it into the compartment until a white knob locks the battery with a click sound.

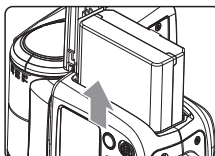

- 3 To unload the battery, tap the white knob and the battery pack will pop out. Then close the compartment.

• Battery Level Indication

Make sure the battery pack is securely loaded in the flash. Check the battery level indication on the LCD panel to see the remaining battery level.

Battery Level Indication	Meaning
	Full
	Middle
	Low
	Battery power will be empty and need to be charged immediately.

Attaching to a Camera

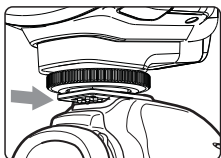

- 1 Attach the Camera Flash.
 - Slip the camera flash's mounting foot into the camera's hotshoe all the way.

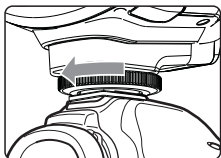

- 2 Secure the Camera Flash.
 - Rotate the lock ring on the mounting foot until it locks up.

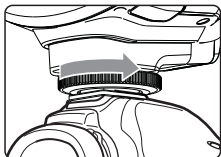

- 3 Detach the Camera Flash.
 - Rotate the lock ring on the mounting foot until it is loosened.

Power Management

Use ON/OFF Power Switch to power the flash unit on or off. Turn off if it will not be used for an extended period of time. Setting as a master flash, it will turn the power off automatically after a certain period (approx. 90 seconds) of idle use. Pressing the camera shutter halfway or pressing any flash button will wake up the flash unit. Setting as a slave flash, it will enter sleep mode after a certain period (adjustable, 60 minutes by default) of idle use. Pressing any flash button will wake it up.

C.Fn Disabling Auto Power Off function is recommended when the flash is used off camera. (C.Fn-01, see P22)

C.Fn Slave Auto Power Off Timer is set to 60 minutes by default. Another option "30 minutes" is available. (C.Fn-10, see P22)

Flash Mode—E-TTL Autoflash

This flash has three flash modes: **E-TTL**, **Manual (M)**, and **Multi** (Stroboscopic). In **E-TTL** mode, the camera and the flash will work together to calculate the correct exposure for the subject and the background. In this mode, multiple TTL functions are available: FEC, FEB, FEL, HSS, second curtain sync, modeling flash, control with the camera's menu screen.

* Press **<MODE>** Mode Selection Button and three flash modes will display on the LCD panel one by one with each pressing.

ETTL Mode

Press **<MODE>** Mode Selection Button to enter E-TTL mode. The LCD panel will display **<ETTL>**.

- Press the camera release button halfway to focus. The shutter speed and aperture will be displayed in the viewfinder.
- When the shutter button is fully pressed, the flash will fire a pre-flash that the camera will use to calculate exposure and flash output the instant before the photo is taken.

! When this icon  appears on the LCD panel, it means the flash unit is at the max. power output. If still underexposure, please make settings on your camera in terms of shutter speed, aperture, ISO, etc.

FEC: Flash Exposure Compensation

With FEC function, this flash can adjust from -3 to +3 in 1/3rd stops. It is useful in situations where minor adjusting of the TTL system is needed based on the environment.

Setting FEC:

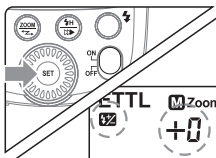

- 1 Press **<WB>** button. The icon **<WB>** and flash exposure compensation amount will blink on the LCD panel.

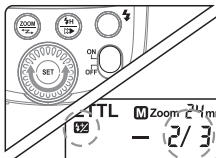

- 2 Set the flash exposure compensation amount.
 - Turn the Select Dial to set the amount.
 - To cancel the flash exposure compensation, set the amount to "+0".

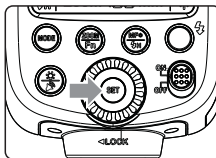

- 3 Press **<WB>** button again to confirm the setting. Then it turns to FEB settings.

FEB: Flash Exposure Bracketing

You can take three flash shots while automatically changing the flash output for each shot from -3 to +3 in 1/3rd stops. The camera will record three images with different exposures: one exposed according to camera calculations, one over-exposed and another under-exposed. Over and under exposure amount is user adjustable. This function helps get correct exposure especially in shooting moving objects or when environmental lights are complex.

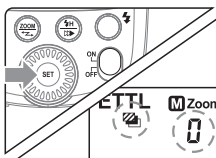

- 1 Press **<WB>** button. The icon **<WB>** and the exposure bracketing amount will blink on the LCD panel.

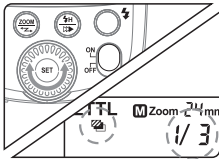

- 2** Set the exposure bracketing amount. Turn the Select Dial to set the amount.

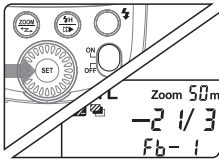

- 3** Press $\langle \text{SET} \rangle$ button again to confirm the setting. Then your **FEC** and **FEB** settings are displayed on the LCD panel.

- FEB will be cancelled after three photos are taken.
 - For best results, set the camera drive mode to "single" and ensure the flash is ready before shooting.
 - FEB can be used with FEC and FEL.
- C.Fn** You can prevent the FEB from being cancelled automatically after three photos are taken. (C.Fn-03, see P22)
- C.Fn** The FEB shooting sequence can be changed. (C.Fn-04, see P22)

FEL: Flash Exposure Lock

FEL can lock the correct flash exposure setting for any part of the scene.

With $\langle \text{ETTL} \rangle$ displayed on the LCD panel, press the camera's $\langle \text{FEL} \rangle$ button. If the camera does not have the $\langle \text{FEL} \rangle$ button, press the $\langle * \rangle$ button.

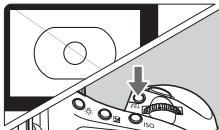

- 1 Focus the subject.
- 2 Press the $\langle \text{FEL} \rangle$ button.
 - Aim the subject at the center of the viewfinder and press $\langle \text{FEL} \rangle$ button.
 - The camera flash will fire a preflash and the required flash output for the subject is retained in memory.
 - Each time the $\langle \text{FEL} \rangle$ button is pressed, a preflash will be fired and a new flash exposure setting will be locked.

- If the subject is too far away and underexposure, the $\langle \downarrow \rangle$ icon will blink in the viewfinder. Move closer to the subject and try the FE lock again.
- If $\langle \text{ETTL} \rangle$ is not displayed on the LCD panel, FE lock cannot be set.
- If the subject is too small, FE lock might not be very effective.

High-Speed Sync

High Speed Sync (FP flash) enables the flash to synchronize with all camera shutter speeds. This is convenient when you want to use aperture priority for fill-flash portraits.



- Select $\langle \text{H} \rangle$.
- Press $\langle \text{H} \rangle$ button so that $\langle \text{H} \rangle$ is displayed.
 - Check that $\langle \text{H} \rangle$ is displayed in the viewfinder.

- If you set a shutter speed that is the same as or slower than the camera's maximum flash sync speed, $\langle \text{H} \rangle$ will not be displayed in the viewfinder.
- With high-speed sync, the faster the shutter speed, the shorter the effective flash range.
- To return to normal flash, press $\langle \text{H} \rangle$ button again. Then $\langle \text{H} \rangle$ will disappear.
- Multi flash mode cannot be set in high-speed sync mode.
- Over-temperature protection may be activated after 15 consecutive high-speed sync flashes.

Second-Curtain Sync

With a slow shutter speed, you can create a light train following the subject. The flash fires right before the shutter closes.



- Press $\langle \text{H} \rangle$ button so that $\langle \text{H} \rangle$ is displayed on the LCD panel.

M: Manual Flash

The flash output is adjustable from 1/1 full power to 1/128th power in 1/3rd stop increments. To obtain a correct flash exposure, use a hand-held flash meter to determine the required flash output.

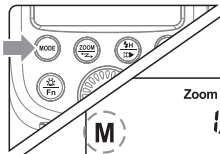

- 1** Press $\langle \text{MODE} \rangle$ button so that $\langle \text{M} \rangle$ is displayed.

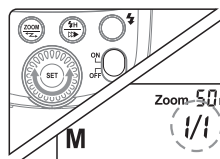

- 2** Turn the Select Dial to choose a desired flash output amount.

Flash Output Range

The following table makes it easier to see how the stop changes in terms of f/stop when you increase or decrease the flash output. For example, when you decrease the flash output to 1/2, 1/2-0.3, or 1/2-0.7, and then increase the flash output to more than 1/2, 1/2+0.3, 1/2+0.7, and 1/1 will be displayed.

Figures displayed when reducing flash output level→

1/1	1/1-0.3	1/1-0.7	1/2	1/2-0.3	1/2-0.7	1/4
	1/2+0.7	1/2+0.3		1/4+0.7	1/4+0.3	

← Figures displayed when increasing flash output level

Multi: Stroboscopic Flash

With stroboscopic flash, a rapid series of flashes is fired. It can be used to capture a multiple images of a moving subject in a single photograph.

You can set the firing frequency (number of flashes per sec. expressed as Hz), the number of flashes, and the flash output.

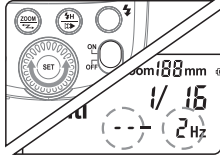
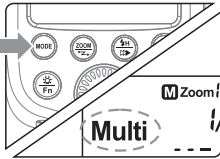

- 1 Press \langle MODE \rangle button so that \langle MULTI \rangle is displayed.
- 2 Turn the Select Dial to choose a desired flash output.
- 3 Set the flash frequency and flash times.
 - Press \langle SET \rangle button to select the item (blinks).
 - Turn the Select Dial to set the number and press \langle SET \rangle button again to confirm. The next item to be set will blink.
 - After you finish the setting, press \langle SET \rangle button and all the settings will be displayed.

Calculating the Shutter Speed

During stroboscopic flash, the shutter remains open until the firing stops. Use the formula below to calculate the shutter speed and set it with the camera.

$$\text{Number of Flashes / Flash Frequency} = \text{Shutter Speed}$$

For example, if the number of flashes is 10 and the firing frequency is 5 Hz, the shutter speed should be at least 2 seconds.

- ▲ To avoid overheating and deteriorating the flash head, do not use stroboscopic flash more than 10 times in succession. After 10 times, allow the camera flash to rest for at least 15 minutes. If you try to use the stroboscopic flash more than 10 times in succession, the firing might stop automatically to protect the flash head. If this happens, allow at least 15 minutes' rest for the camera flash.

- Stroboscopic flash is most effective with a highly reflective subject against a dark background.
- Using a tripod and a remote control is recommended.
- A flash output of 1/1 and 1/2 cannot be set for stroboscopic flash.
- Stroboscopic flash can be used with "buLb".
- If the number of flashes is displayed as "--", the firing will continue until the shutter closes or the battery is exhausted. The number of flashes will be limited as shown by the following table.

Maximum Stroboscopic Flashes:

Flash output	Hz	1	2	3	4	5	6-7	8-9
1/4		7	6	5	4	4	3	3
1/8		14	14	12	10	8	6	5
1/16		30	30	30	20	20	20	10
1/32		60	60	60	50	50	40	30
1/64		90	90	90	80	80	70	60
1/128		100	100	100	100	100	90	80

Flash output	Hz	10	11	12-14	15-19	20-50	60-199
1/4		2	2	2	2	2	2
1/8		4	4	4	4	4	4
1/16		8	8	8	8	8	8
1/32		20	20	20	18	16	12
1/64		50	40	40	35	30	20
1/128		70	70	60	50	40	40

If the number of flashes is displayed as "--", the maximum number of flashes will be as shown in the following table regardless of the flash frequency.

Flash Output	1/4	1/8	1/16	1/32	1/64	1/128
Number of Flashes	2	4	8	12	20	40

Wireless Flash

This product supports wireless flash application and functions as either a master or a slave unit. As a master unit, it can control Canon speedlites e.g. 580EXII, 600EX-RT via wireless. As a slave unit, it can receive wireless signals of Canon speedlites e.g. 580EXII, 600EX-RT and commanders of Canon cameras e.g. 7D/60D/600D.

- You can set up two to three slave groups for E-TTL II autofocus shooting. With E-TTL II autofocus, you can easily create various lighting effects.

- Any flash settings (of flash exposure compensation, high-speed sync, FE lock, FEB, manual flash, Multi flash) on the master unit will be automatically sent to the slave units. So the only thing you need to do is to set the master unit to E TTL mode without any operation for the slave units at all during the shooting.
- This flash can work in E TTL autoflash, M manual flash, and Multi stroboscopic flash modes when set as a master unit.

Positioning and Operation Range

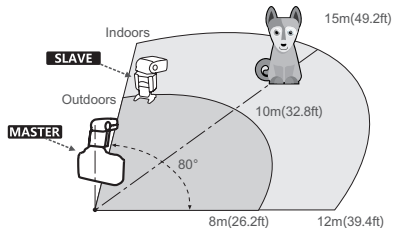

- Even with multiple slave units, the master unit can control all of them via wireless.
- In this user manual, "master unit" refers to the camera flash on a camera and "slave unit" will be controlled by the master unit.

1. Wireless Settings

You can switch between normal flash and wireless flash. For normal flash shooting, be sure to set the wireless setting to OFF.

Master Unit Setting

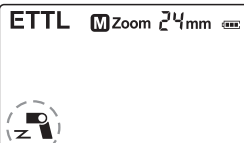

- 1 Press $\left(\frac{\text{ZOOM}}{\text{ZOOM}}$) button for 2 seconds or longer until the icon in dotted lines blinks.

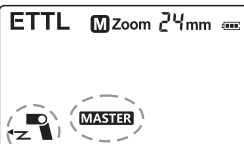

- 2 Set it as the master unit.
 - Turn the Select Dial until <MASTER> blinks. Press the <SET> button to confirm the settings.
 - <MASTER> and <CH.> will be displayed, meaning the flash is set as the master unit.

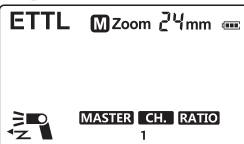

Slave Unit Setting

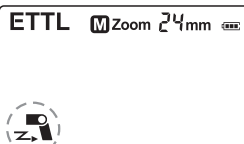

- 1 Press $\left(\frac{\text{ZOOM}}{\text{ZOOM}}$) button for 2 seconds or longer until the icon in dotted lines blinks.

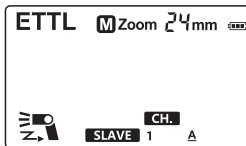

- 2 Set it as the slave unit.
 - Turn the Select Dial until <SLAVE> blinks. Press the <SET> button to confirm the settings.
 - <SLAVE> and <CH.> will be displayed, meaning the flash is set as the slave unit.

Optic S1 Secondary Unit Setting

In M manual flash mode, this flash can function as an optic S1 secondary flash with optic sensor. With this function, the flash will fire synchronously when the main flash fires, the same effect as that by the use of radio triggers. This helps create multiple lighting effects.

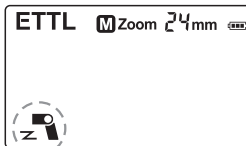

- 1 Press $\left(\frac{\text{ZOOM}}{\text{ZOOM}}$) button for 2 seconds or longer until the icon in dotted lines blinks.

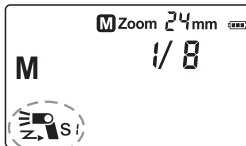

- 2 Set it as an optic S1 secondary unit.
 - Turn the Select Dial until <S1> blinks. Press the <SET> button to confirm the settings.

Optic S2 Secondary Unit Setting

The flash can also function as an optic S2 secondary flash with optic sensor in M manual flash mode. This is useful when cameras have pre-flash function. With this function, the flash will ignore a single "pre-flash" from the main flash and will only fire in response to the second, actual flash from the main unit.

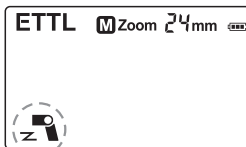

- 1 Press $\left(\frac{\text{ZOOM}}{\text{ZOOM}}$) button for 2 seconds or longer until the icon in dotted lines blinks.

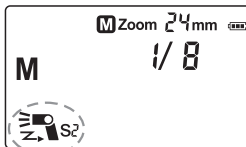

- 2 Set it as an optic S2 secondary unit.
 - Turn the Select Dial until <S2> blinks. Press the <SET> button to confirm the settings.

- S1 and S2 optic triggering is only available in M manual flash mode.

2. Fully Automatic Wireless Flash

This uses E-TTL autoflash to control the total flash output and make all groups of flashes fire at an average of the total flash output.

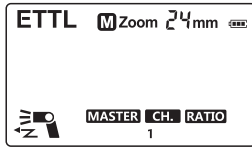

- 1 Attach a camera flash onto the camera and set it as the master unit.

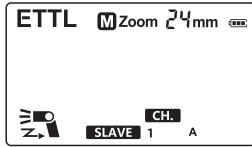

- 2 Set the other camera flash(es) as the wireless slave unit(s).

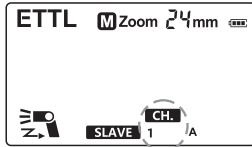

- 3 Check the communication channel. If the master unit and slave unit(s) are set to a different channel, set them to the same channel.

- 4 Position the camera and flashes.

- 5 Set the master unit's flash mode to <ETTL>. For shooting, <ETTL> will automatically be set for the slave unit(s).

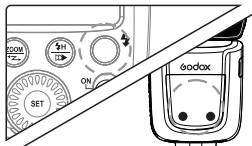

- 6 Check that the flash is ready.

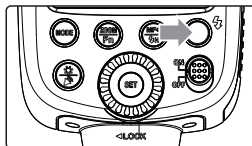

- 7 Check the flash operation. Press the master unit's Test Button and the slave unit will fire. If not, adjust the slave unit's angle toward the master unit and distance from the master unit.

- 8 Set the camera in the same way as with normal flash shooting.

- No matter where the slave unit's flash head is towards, be sure to make its wireless sensor faces the master unit. Also ensure that the slave unit is placed within the effective transmission range of the master unit. Do not place any obstacles between the master unit and the slave unit(s). Obstacles may block the transmission of wireless signals.
- After positioning the slave unit(s), be sure to test the wireless flash operation before shooting.

3. Master Unit's Flash OFF

When the master unit is set to OFF, only the slave units will fire a flash.

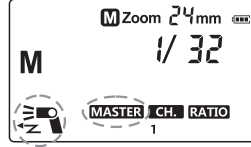

- 1 Set it as the master unit. Press <MODE> button for few times until <M> and <MASTER> blink.

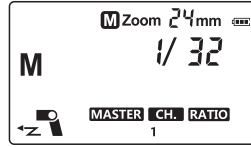

- 2 Disable the master unit's flash firing.
 - Turn the Select Dial until <Z> is displayed. Press the <SET> button to confirm.

- Even if the master unit flash firing is disabled, it still fires a preflash to transmit wireless signals.

4. Setting the Communication Channel

If there are other wireless flash systems nearby, you can change the channel IDs to prevent signal interference. The channel IDs of the master unit and the slave unit(s) must be set to the same.

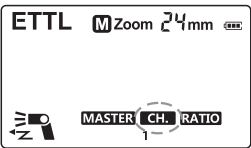

- 1 Press <MODE> button for two times so that <CH.> blinks.

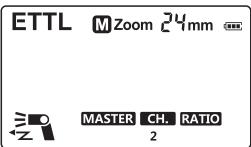

- 2 Set a channel ID.
 - Turn the Select Dial to choose a channel ID and press the <SET> button to confirm.

5. Setting the Flash Output for Slave Units

In M manual and Multi stroboscopic flash modes, you can set a different flash output for each slave unit. All settings are done with the master unit.

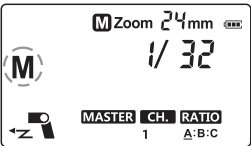

- 1 Press <MODE> button to have <M> or <Multi> displayed.

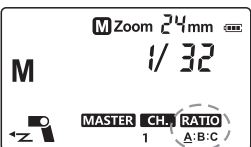

- 2 Press <MODE> button so that <A> blinks on the LCD panel.

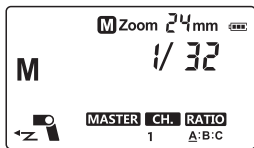

3 Select the flash ratio. Turn the Select Dial to choose < A:B > or < A:B:C > . Pressing the < SET > button will confirm the settings.

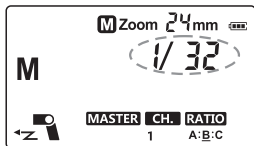

4 Set the flash output.

- The flash unit selects < A > slave ID by default. The selected ID will be underlined. After you finish all the settings for < A > , press < SET > button will start the settings for < B > .
- Turn the Select Dial to choose a desired flash output.

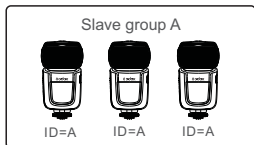

About Slave Group Control
If three slave units are all set to < A > in terms of slave ID, these slave units will be controlled as if they were one camera flash in slave group A.

Other Applications

Wireless Control Function

The flash unit is built in with a Wireless Control Port so that you can wirelessly adjust the power level of the flash and the flash triggering. To control the flash wirelessly, you need a FT-16S remote control set (on-camera and on-flash). Insert its receive end into the Wireless Control Port on the flash and insert the transmit end into the camera hot shoe. Settings made on the hotshoe-mounted transmit and receive ends will be wirelessly communicated to the flash. Then you can press the camera shutter release button to trigger the flash. You can also hold the transmit end at hand to control your off-camera flash.

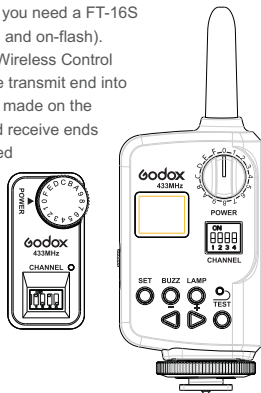

- When the flash unit receives wireless signals, is shown on the LCD display.
- For full instructions on the use of FT series remote control, see its user manual.

Sync Triggering

The Sync Cord Jack is a $\Phi 2.5$ mm plug. Insert a trigger plug here and the flash will be fired synchronously with the camera shutter.

Modeling Flash

If the camera has a depth-of-field preview button, pressing it will fire the flash continuously for 1 second. This is called modeling flash. It enables you to see the shadow effects on the subject and the lighting balance. You can fire the modeling flash during wireless or normal flash shooting.

- To avoid overheating and deteriorating the flash head, do not fire the modeling flash for more than 10 consecutive times. If you fire the modeling flash 10 consecutive times, allow at least 10 minutes' break for the camera flash.
- The modeling flash cannot be fired with the EOS 300 and Type-B cameras.

Auto Focus Assist Beam

In poorly-lit or low-contrast shooting environments, the built-in auto focus assist beam will automatically light on to make it easier for autofocus. The beam will light up only when autofocus is difficult and get out as soon as the autofocus becomes correct.

- If you find the auto focus assist beam does not light up, this is because the camera has got a correct autofocus.

Position	Effective Range
Center	0.6~10m / 2.0~32.8 feet
Periphery	0.6~5m / 2.0~16.4 feet

Bounce Flash

By pointing the flash head toward a wall or ceiling, the flash will bounce off the surface before illuminating the subject. This can soften shadows behind the subject for a more natural-looking shot. This is called bounce flash.

To set the bounce direction, hold the flash head and turn it to a satisfying angle.

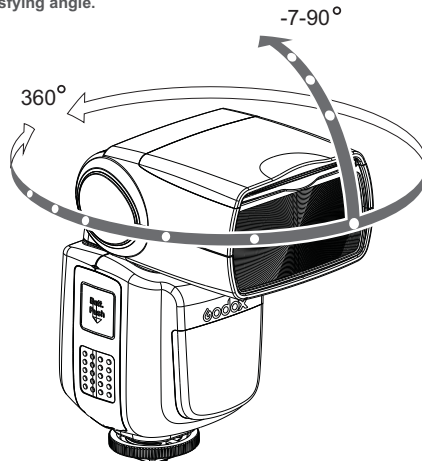

- If the wall or ceiling is too far away, the bounced flash might be too weak and result in underexposure.
- The wall or ceiling should be a plain, white color for high reflectance. If the bounce surface is not white, a color cast may appear in the picture.

Creating a Catchlight

With the catchlight panel, you can create a catchlight in the subject's eyes to add life to the facial expression.

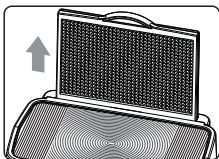

1 Point the flash head upward by 90°.

2 Pull out the wide panel. The catchlight panel will come out at the same time.

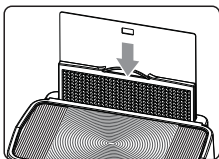

3 Push the wide panel back in.

- Push in only the wide panel.
- Follow the same procedures as for bounce flash.

- ▲ Point the flash head straight ahead and then upward by 90°. The catchlight will not appear if you swing the flash head left or right.
- For best catchlight effect, stay 1.5m/4.9ft away from the subject.

ZOOM: Setting the Flash Coverage and Using the Wide Panel

The flash coverage can be set automatically or manually. It can be set to match the lens focal length from 24 mm to 105mm. Also, with the built-in wide panel, the flash coverage can be expanded for 14mm wide-angle lenses.

ETTL **M** Zoom **188mm** **455**

In Manual Zoom mode, press the $\langle \text{Zoom} \rangle$ button.

- Turn the Select Dial to change the flash coverage. If $\langle \text{M} \rangle$ is not displayed, the flash coverage will be set automatically.

- If you set the flash coverage manually, make sure it covers the lens focal length so that the picture will not have a dark periphery.

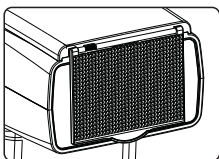

Using the Wide Panel

Pull out the wide panel and place it over the flash head as shown. The flash coverage will then be extended to 14 mm.

- The catchlight panel will come out at the same time. Push the catchlight panel back in.
- The $\langle \text{Zoom} \rangle$ button will not work.

C.Fn: Setting Custom Functions

The following table lists the available and unavailable custom functions of this flash. The icon "√" indicates the flash custom function is supported but "0" indicates the custom function is not supported.

C.Fn Custom Functions				
Custom Functions No.	Function	Setting No.	Settings & Description	Support or Not
C.Fn-00	Distance indicator display	0	Meters (m)	0
		1	Feet (ft)	
C.Fn-01	Auto power off	0	Enabled	√
		1	Disabled	
C.Fn-02	Modeling flash	0	Enabled (Depth-of-field preview button)	0
		1	Enabled (Test firing button)	
		2	Enabled (with both buttons)	
		3	Disabled	
C.Fn-03	FEB auto cancel	0	Enabled	√
		1	Disabled	
C.Fn-04	FEB sequence	0	0 -> - -> +	√
		1	- -> 0 -> +	
C.Fn-05	Flash metering mode	0	E-TTL II/E-TTL	0
		1	TTL	
		2	External metering: Auto	
		3	External metering: Manual	
C.Fn-06	Quickflash with continuous shot	0	Disabled	0
		1	Enabled	
C.Fn-07	Test firing with autoflash	0	1/32	0
		1	Full output	
C.Fn-08	AF-assist beam firing	0	Enabled	0
		1	Disabled	
C.Fn-09	Auto zoom for sensor size	0	Enabled	0
		1	Disabled	
C.Fn-10	Slave auto power off timer	0	60 minutes	√
		1	30 minutes	
C.Fn-11	Slave auto power off cancel	0	Within 8 hours	0
		1	Within 1 hour	
C.Fn-12	Flash recycle with external power source	0	Flash and external power	0
		1	External power source	
C.Fn-13	Flash exposure metering setting	0	Speedlite button and dial	0
		1	Speedlite dial only	

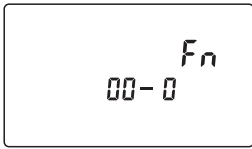

1 Press < $\frac{Fn}{Fn}$ > button for 2 seconds or longer until < Fn > is displayed.

2 Select the Custom Function No.

- Turn the Select Dial to set the Custom Function No.

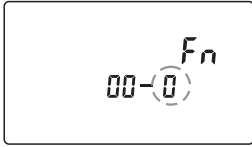

3 Change the setting.

- Press < (set) > button and the setting No. blinks.

- Turn the Select Dial to set the desired number.

Pressing < (set) > button will confirm the settings.

- After you set the Custom Function and press < (mode) > button, the camera will be ready to shoot.

Control with the Camera's Menu Screen

If the camera flash is attached to an EOS camera which has a speedlite control function, the flash can be controlled using the camera's menu screen. For the menu operation procedure, refer to your camera's instruction manual.

• Setting Camera Flash Functions

The following flash functions are settable according to different flash modes.

1. Flash mode
2. Shutter sync (1st/2nd curtain, high speed sync)
3. FEB
4. Flash exposure compensation
5. Flash firing
6. Clear camera flash's settings

• Custom Functions of Camera Flash

C.Fn-01, C.Fn-03, C.Fn-04, and C.Fn-10

Clear All Flash Custom Functions

Flash function settings screen

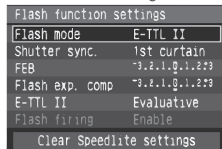

Flash C.Fn settings screen

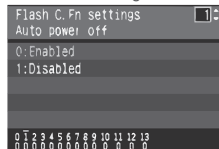

* Screens from the EOS-1D Mark III.

- If flash exposure compensation has already been set with the camera flash, flash exposure compensation cannot be set with the camera. To set it with the camera, the camera flash's flash exposure compensation must be set to zero.
- If any Flash Custom Functions and flash settings other than flash exposure compensation have been set by both the camera and the flash, the latest settings will take effect.

Protection Function

1. Over-Temperature Protection

- To avoid overheating and deteriorating the flash head, do not fire more than 30 continuous flashes in fast succession at 1/1 full power. After 30 continuous flashes, allow a rest time of at least 10 minutes.
- If you fire more than 30 continuous flashes and then fire more flashes in short intervals, the inner over-temperature protection function may be activated and make the recycling time about 10 to 15 seconds. If this occurs, allow a rest time of about 10 minutes, and the flash unit will then return to normal.
- When the over-temperature protection is started, is shown on the LCD display.

Number of flashes that will activate over-temperature protection:

Power Output Level	Number of Flashes
1/1	30
1/2 +0.7	40
1/2 +0.3	50
1/2	60
1/4(+0.3,+0.7)	100
1/8(+0.3,+0.7)	200
1/16(+0.3,+0.7)	300
1/32(+0.3,+0.7)	500
1/64(+0.3,+0.7)	1000
1/128(+0.3,+0.7)	

Number of flashes that will activate over-temperature protection in high-speed sync triggering mode:

Power Output	Times
1/1	15
1/2(+0.3,+0.7);	20
1/4(+0.3,+0.7)	30
1/8(+0.3,+0.7);	
1/16(+0.3,+0.7)	40
1/32(+0.3,+0.7);	
1/64(+0.3,+0.7);	50
1/128(+0.3,+0.7);	

2. Other Protections

The system provides real-time protection to secure the device and your safety. The following lists prompts for your reference:

Prompts on LCD Panel	Meaning
E1	A failure occurs on the recycling system so that the flash cannot fire. Please restart the flash unit. If the problem still exists, please send this product to a maintenance center.
E2	The system gets excessive heat. Please allow a rest time of 10 minutes.
E3	The voltage on two outlets of the flash tube is too high. Please send this product to a maintenance center.

Technical Data

Kit Model	V860C Kit (with battery & charger)
Flash-Only Model	V860C (only flash unit)
• Type	
Compatible Cameras	Canon EOS cameras (E-TTL II autoflash)
Guide No.	58 (m ISO 100)
(1/1 output @ 105mm)	190 (feet ISO 100)
Flash Coverage	24 to 105mm (14mm with wide panel)
	• Auto zoom (Flash coverage set automatically to match the lens focal length and image size)
	• Manual zoom
	• Swinging/tilting flash head (bounce flash): 0 to 360° horizontally and -7° to 90° vertically
Flash Duration	1/300 to 1/20000 seconds
• Exposure Control	
Exposure control system	E-TTL II autoflash and manual flash
Flash exposure compensation (FEC)	Manual. FEB: ±3 stops in 1/3 stop increments (Manual FEC and FEB can be combined.)
FE lock	With <FEL> button or < * > button
Sync mode	High-speed sync (up to 1/8000 seconds), first-curtain sync, and second-curtain sync
Multi flash	Provided (up to 100 times, 199Hz)
• Wireless Flash	
Wireless flash function	Master, Slave, Off
Controllable slave groups	3 (A, B, and C)
Transmission range (approx.)	Indoors: 12 to 15 m / 39.4 to 49.2 ft. Outdoors: 8 to 10 m / 26.2 to 32.8 ft. Master unit reception angle: ±40° horizontally, ±30° vertically
Channels	4 (1, 2, 3, and 4)
Slave-ready indicator	Two red indicators blink
Modeling flash	Fired with camera's depth-of-field preview button
• Auto Focus Assist Beam	
Effective range (approx.)	Center: 0.6~10m / 2.0~32.8 feet Periphery: 0.6~5m / 2.0~16.4 feet
• Power Supply	
Power source	11.1V/2000mAh Li-ion polymer battery
Recycle time	< 1.5 seconds. Red LED indicator will light up when the flash is ready.
Full power flashes	Approx. 650
Power saving	Power off automatically after approx. 90 seconds of idle operation. (60 minutes if set as slave)
• Sync Triggering Mode	Hotshoe, 2.5mm sync line, Wireless control port
• Color Temperature	5600±200k
• Dimensions	
W x H x D	64*76*190 mm
Weight without battery	420g
Weight with battery	540g

Troubleshooting

If there is a problem, refer to this Troubleshooting Guide.

The Camera Flash cannot be charged.

- The battery is installed in the wrong direction.
→Install the battery in the correct direction.
- The camera flash's internal battery is exhausted.
→If <□> appears and blinks on the LCD panel, replace the battery immediately.

The Camera Flash does not fire.

- The camera flash is not attached securely to the camera.
→Attach the camera's mounting foot securely to the camera.
- The electrical contacts of the Camera Flash and camera are dirty.
→Clean the contacts.
- < ƒ > or < ƒH > is not displayed in the view finder of camera.
→Wait until the flash is fully recycled and the flash ready indicator lights up.
- If the flash ready indicator lights up, but < ƒ > or < ƒH > is not displayed in the view finder, check whether this flash unit is securely attached to the camera hotshoe.
- If the flash ready indicator does not light up after a long wait, check whether the battery power is enough. If the battery power is low, <□> will appear and blink on the LCD panel. Please replace the battery immediately.

The power turns off by itself.

- After 90 seconds of idle operation, auto power off took effect if the flash is set as master.
→Press the shutter button halfway or press any flash button to wake up.
- After 60 minutes (or 30 minutes) of idle operation, the flash unit will enter sleep mode if it is set as slave.
→Press any flash button to wake up.

Auto zoom does not work.

- The camera flash is not attached securely to the camera.
→Attach the camera flash's mounting foot to the camera.

The flash exposure is underexposed or overexposed.

- There was a highly reflective object (e.g. glass window) in the picture.
→Use FE lock (FEL).
- You used high-speed sync.
→With high-speed sync, the effective flash range will be shorter. Make sure the subject is within the effective flash range displayed.
- You used Manual Flash mode.
→Set the flash mode to **ETTL** or modify the flash output.

Photos have dark corners or only parts of the target subject are illuminated.

- The focal length of lens exceeds the flash coverage.
→Check the flash coverage you set. This flash unit has the flash coverage between 24 and 105mm, which fits medium-format cameras. Pull the wide panel out to extend the flash coverage.

Firmware Upgrade

This flash supports firmware upgrade through the USB port. Update information will be released on our official website.

- USB connection line is not included in this product. The USB port is a standard Micro USB socket. Common USB connection line is applicable.

Compatible Camera Models

This flash unit can be used on the following

Canon EOS series camera models:

5D Mark III	5D Mark II	6D	7D	60D	50D	40D	30D	650D
600D	550D	500D	450D	400D Digital	1100D	1000D		

- This table only lists the tested camera models, not all Canon EOS series cameras. For the compatibility of other camera models, a self-test is recommended.
Rights to modify this table are retained.

Maintenance

- Shut down the device immediately should abnormal operation be detected.
- Avoid sudden impacts and the product should be dedusted regularly.
- It is normal for the flash tube to be warm when in use. Avoid continuous flashes if unnecessary.
- Maintenance of the flash must be performed by our authorized maintenance department which can provide original accessories.
- This product, except consumables e.g. flash tube, is supported with a one-year warranty.
- Unauthorized service will void the warranty.
- If the product had failures or was wetted, do not use it until it is repaired by professionals.
- Changes made to the specifications or designs may not be reflected in this manual.